

PARRILLAS COMBINADAS

DRAGO



CUERPO

Exterior fabricado en acero inoxidable e interior fabricado en lámina aluminizada.

CHIMENEA

Chimenea fabricada en acero inoxidable.

PARRILLAS

Parrillas individuales de 12" x 12" de hierro fundido y recubiertas con pintura de alto calor.

VÁLVULAS

Válvulas de Gas certificadas por CSA

PLANCHA

Escurridera de plancha con embutido, para facilitar la limpieza

PERILLAS

Nuevo diseño en perillas de quemadores

QUEMADORES

Quemadores Tubulares de 2" de diámetro de Acero Inoxidable con capacidad de 20,000 BTU's

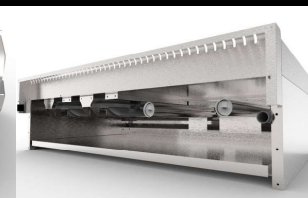
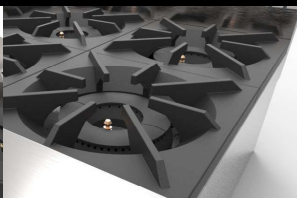
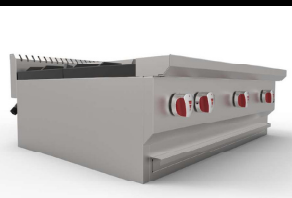

DIMENSIONES GENERALES

CG-20 PD SILVER

CG-40 PD SILVER

CG-40 P SILVER

VISTA FRONTAL

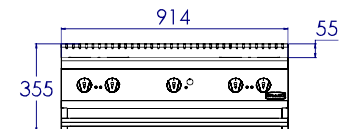
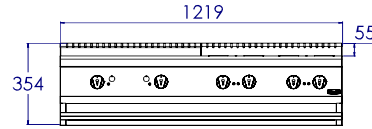
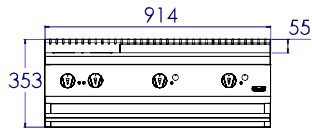

VISTA SUPERIOR

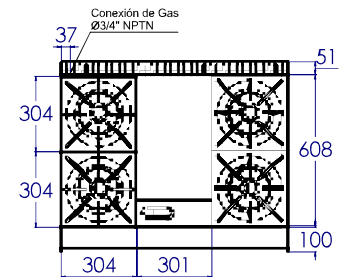
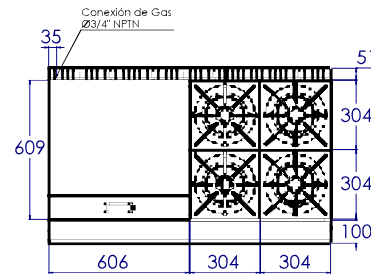
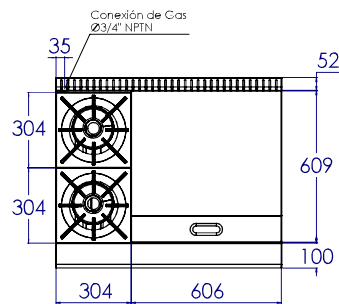

MEDIDAS EN mm

MODELO	A	B	C	PERILLAS	QUEMADORES	BTU's	PESO DEL EQUIPO (Kg)	PESO DEL EQUIPO ENHUACALADO (Kg)
CG-20PD	914	767	353	4	2	80,000	72	110
CG-40PD	1219	767	355	6	4	160,000	99	132
CG-40P	914	767	354	5	4	140,000	72	110

Instalación de conexión al gas:

- Equipos a baja presión
- Presión requerida gas lp 11" Columna de Agua
- Presión requerida gas natural 5" Columna de Agua
- Entrada principal de gas ¾" NPT Macho.

VISTA LATERAL

